

- * 华源铝复合板
- * 华源铜复合板
- * 华源钛锌复合板
- * 华源不锈钢复合板
- * 华源镀锌钢复合板
- * 华源三维复合板
- * 华源铝蜂窝复合板
- * 华源金属石材复合板
- * 华源双金属复合板
- * 华源铝镁锰板

华源

专业生产金属复合板 20 年

企 业 和 产 品 简 介
C A T A L O G



上海华源复合新材料有限公司

网址: www.huayuanfu.com

地址: 上海市青浦区新金路 888 号

电话: 021-59732001



官方网站



官方微信

坚守品质 精准制造 高端金属复合板 全程数控 整套加工



CONTENTS

目录

04 企业介绍
About Us

14 华源铜复合板
Huayuan Copper Composite Panel

06 华源金属复合板
(产品概述)
Huayuan Metal Composite Panel

15 华源钛锌复合板
Huayuan Zinc Composite Panel

08 华源铝复合板
Huayuan Aluminium Composite Panel

16 华源不锈钢复合板
Huayuan Stainless Steel Composite Panel

10 特别推荐
Special Recommendation

17 华源镀锌钢复合板
Huayuan Galvanized Steel Composite Panel

- 10 华源 A2 不燃铝复合板
- 11 华源高强度粒子涂层
- 11 华源幻彩铝复合板
- 12 华源阳极氧化铝复合板
- 13 华源金属覆膜板

18 华源三维复合板
Huayuan Aluminium C-core Panel

19 华源铝蜂窝复合板
Huayuan Aluminium Honeycomb Panel

20 华源金属石材复合板
Huayuan Metal Stone Composite Panel

22 华源双金属复合板
Huayuan Bimetal Composite Panel

23 华源复合板安装系统
Huayuan Installation System For Metal Composite Panel

24 华源铝镁锰板
Huayuan Al-Mg-Mn Solid Panel

26 华源金属复合板
生产工艺流程
Huayuan Metal Composite Panel Production Process

28 华源金属复合板
加工方法
Huayuan Metal Composite Panel Processing Method

32 华源产品研发与
测试中心
Huayuan Product Development and Testing Center

33 华源产品加工设备
Huayuan Product Processing Equipment

34 一站式服务
One-Stop Service

36 工程实例选登
Project Reference



About Us 公司介绍

上海华源复合新材料有限公司是中外合资企业，总投资3200万美元，专业生产华源牌&ALUCOBEST金属复合板系列产品：铝复合板、铜复合板、不锈钢复合板、钛锌复合板、镀锌钢复合板、双金属复合板、覆膜抗污复合板、特色铝单板、三维复合板和蜂窝复合板。

公司拥有30000多平方米的标准工业厂房，年产各种华源牌&ALUCOBEST金属复合板800万平方米以上，连续多年被评为上海市高新技术企业，现为中国建筑材料联合会金属复合材料分会副理事长单位、上海市建筑材料行业协会副会长单位。公司在中国大部分省市设有办事处；在全球五大洲设有多个代理商。

公司已通过质量管理体系ISO9001、环境管理体系ISO14001、职业健康安全ISO45001。产品荣获国家级和国际品质认证，通过世界权威检测机构瑞士

SGS、英国INTERTEK 相关检测，达到美国ASTME84、E119、NFPA285、欧盟EN13501和英国BS476标准。公司研制开发的铜复合板、钛锌复合板、不锈钢复合板和双金属复合板等先后获得多项专利。

公司秉持着二十余载在复合金属材料领域上的专注与坚持，高效及高品质的制造流程，以客户为中心、品质技术双驱动的系统管理能力。未来，我们仍以永续经营、树百年企业的态度，为客户提供多元化的产品设计一体化服务作为自我期许与使命，继续朝着“布局全球、服务全球”的中国复合金属材料产业技术先导企业的美好愿景，持续引领着中国金属复合材料行业的发展，不断向前迈进！

Management Systems, ISO45001 for Occupational Health and Safety. The product has won national and international quality certifications, passed the relevant inspections of the world's authoritative testing agency Switzerland SGS and the UK INTERTEK, and reached the American ASTM E84, E119, NFPA285, EU EN13501 and UK BS476 standards. The Copper Composite Panel, Zinc Composite Panel, Stainless Steel Composite Panel and Bimetal Composite Panel developed by our company have obtained several patents.

For more than 20 years, the company adheres to the dedication and persistence in the field of metal composite materials, efficient and high-quality manufacturing process, and the management driven by customer-orientation and quality & technology capabilities. In the future, it shall continue to be committed to growing to a century-old enterprise, to the provision of diversified products and one-stop service comprising design and manufacturing. With the vision of "Global Business, Global Service", it strives to become a pioneering enterprise in China's metal composite materials industry. It continues to lead the development of China's metal composite industry, and continue to move forward.

Shanghai Huayuan New Composite Materials Co., Ltd. is a joint venture, with a total investment of 32 million US Dollar, specializing in manufacturing HUAYUAN brand & ALUCOBEST brand metal composite materials series including Aluminium Composite Panel, Copper Composite Panel, Stainless Steel Composite Panel, Zinc Composite Panel, Galvanized Steel Composite Panel, Bimetal Composite Panel, Film Metal Composite Panel, Specialty Solid Aluminium Panel, Aluminium Core Panel and Aluminium Honeycomb Panel.

The company has more than 30,000 square meters of standard industrial plant, annual output is over 8 million SQM of various Huayuan brand & ALUCOBEST brand metal composite panels. It has been rated as Shanghai High Tech Enterprise for many years. Now the company is the vice-chairman of China Building Materials Industry Association Metal Branch, the vice-chairman of Shanghai Building Materials Industry Association. It has representative offices in most provinces and cities in China and multiple agents in five continents globally.

The company was certified with ISO9001 in Quality Management Systems, ISO14001 in Environmental



Huayuan Metal Composite Panel

华源金属复合板 产品概述



华源金属复合板是采用各类金属为面背板，高压低密度聚乙烯（LDPE）或防火材料为芯层，经热复合而成的新型高档建筑装饰材料。

公司潜心研发，每种金属之间合理配比，结合二十年制造工艺和严谨的生产管理体系，科学加工，赋予了每种金属复合板更强的产品性能。超强的剥离强度、优越的防火性能、良好的耐冲击性、超耐候性、涂层均匀、色彩多样。产品特点：整体强度高、平整性好、重量轻、易加工、易保养、性价比超高。是行业产品中的典范。

Huayuan Metal Composite Panel is a new type of high-grade building decorative material which is made of various types of metal as the top or back sheet, high-pressure low-density polyethylene (LDPE) or fire-resistant material as the core layer.

The company devotes itself to R&D, we apply a reasonable ratio between the production of each kind of metal. We combine 20 years with manufacturing technique, rigorous production management system and scientific processing to offer stronger product performance to each metal composite panel. Excellent peel-off strength, superior fire-resistant performance, good impact resistance, superior weatherproof, uniform coating, and various colours. Product features overall rigidity, extreme flatness, lightweight, easy processing, easy maintenance, and cost-effectiveness. It is a star product in this industry

可选防火芯层

A2（特别推荐）、HFR、FR

OPTIONAL FIRE-RESISTANT CORE

A2 (Special Recommendation), HFR, FR



产品分类

- 铝复合板：铝 | 芯 | 铝
- 铜复合板：铜 | 芯 | 铝（或铜）
- 钛锌复合板：钛锌 | 芯 | 铝（或钛锌）
- 不锈钢复合板：不锈钢 | 芯 | 不锈钢
- 镀锌钢复合板：钢 | 芯 | 钢

PRODUCT CATEGORY

- Aluminium Composite Panel:** Aluminium | Core | Aluminium
- Copper Composite Panel:** Copper | Core | Aluminium (or Copper)
- Zinc Composite Panel:** Zinc | Core | Aluminium (or Zinc)
- Stainless Steel Composite Panel:** Stainless Steel | Core | Stainless Steel
- Galvanized Steel Composite Panel:** Steel | Core | Steel



产品特点

- 强度高
- 板型好、平整度高
- 价格低、重量轻
- 隔热、隔音、避震、防腐
- 防火性能高

PRODUCT CHARACTERISTIC

- High strength
- Stable structure and excellent flatness
- Cost-effective and light weight
- Thermal insulation, sound insulation, shock absorption, and anti-corrosion
- High fire resistance



产品规格

- 总厚：3mm | 4mm | 5mm | 6mm
- 宽度：600-1220 | 1220-2000mm
- 长度：2440mm | 2000-6000mm（可定尺）
- * 详细规格或有特殊要求敬请联系公司销售代表

PRODUCT SPECIFICATION

- Total Thickness:** 3mm | 4mm | 5mm | 6mm
- Width:** 600-1220 | 1220-2000mm
- Length:** 2440 mm | 2000-6000 mm (Customizable)
- * Detailed specifications or special requirements, please contact the company's sales representative

Huayuan Aluminium Composite Panel

华源铝复合板

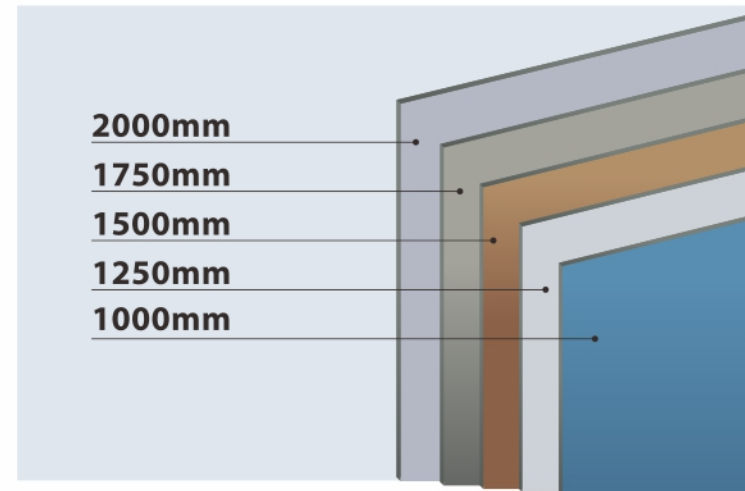

图例 上海仁恒公园世纪

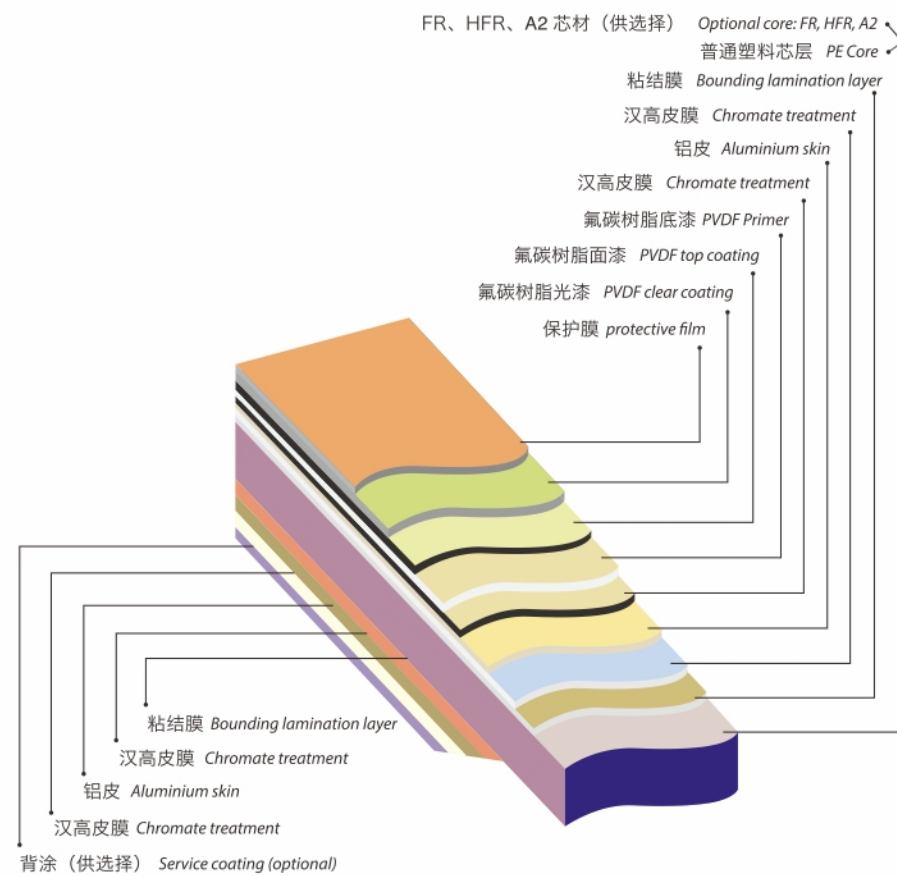

防火等级 (可选)

- A2** 特别推荐
燃烧性能符合 GB8624-2012 中 A(A2-s1,d0,t0) 级的技术要求。
- HFR**
燃烧性能符合 GB/T17748-2016 中高阻燃型的技术要求。
- FR**
燃烧性能符合 GB/T17748-2016 中阻燃型的技术要求。

种类 / 特点

聚酯漆 (室内) | 氟碳漆 (室外)
 EVE / FEVE (高光) | 阳极氧化
 拉丝 | 镜面 | 绒面 (抗刮) | 纳米 (自洁) | 幻彩
 冰花 (抗刮) | 木纹 (烤漆 / 覆膜)
 石纹 | 竹纹

FIRE-RESISTANCE GRADE

- A2** Special Recommended
The combustion performance meets the technical requirements of Class A (A2-s1, d0, t0) in GB8624-2012.
- HFR**
The combustion performance meets the technical requirements of GB/T17748-2016 for high flame-retardant type.
- FR**
The combustion performance meets the technical requirements of flame-retardant type GB/T17748-2016.

CATEGORY / CHARACTERISTIC

Polyester (indoor) | PVDF (outdoor)
 EVE/FEVE(high gloss) | Anodized
 Brushed | Mirror | Satin (anti-scratching) | Nano (self-cleaning) | Chameleon
 Crinkle (anti-scratching) | Wood Grains (coating/film)
 Stone | Bamboo

Huayuan A2 Non-Combustible Aluminium Composite Panel

华源 A2 不燃铝复合板

特别推荐 1



产品结构

以不燃无机矿物质（硅微粉、碳酸钙、氢氧化铝和氢氧化镁等）为芯层，以涂层铝合金为装饰面的一种革命性的高性能轻质防火装饰材料。

防火性能达到 GB 8624-2012 中不燃 A2 级。华源 A2 不燃板具有重量轻、强度高、板面平整度好、涂层质量佳、保温性好、加工方便等优点。适用于高防火要求的幕墙和室内外装饰装修。



PRODUCT STRUCTURE

It is a kind of revolutionary high-performance light fire-proof decorative material with non-combustible inorganic minerals (silicon powder, calcium carbonate, aluminium hydroxide, magnesium hydroxide, etc.) as the core layer and coated aluminium alloy as the decorative surfaces.

The fire-resistant performance has reached the non-combustible A2 grade in GB 8624-2012. Huayuan A2 Non-Combustible Panel has the advantages of light weight, high strength, good flatness of surface, good coating quality, good heat preservation and easy processing. It is suitable for building facade and indoor&outdoor decoration with high fire-resistance requirements.

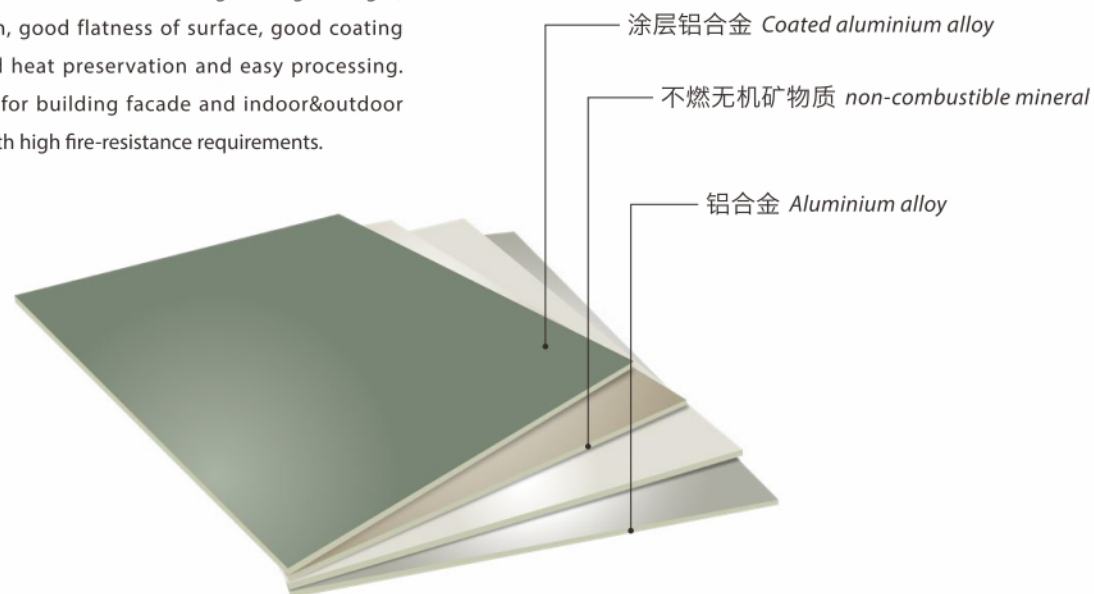

芯层：不燃无机矿物质 Non-Combustible Mineral

Huayuan High Strength Particle Coating

华源高强度粒子涂层

特别推荐 2

高耐久性·高硬度·高绝热

特点

华源高强度涂层具有高耐久性、高硬度、高绝热、节能、不燃、隔音、不结露、长期防霉等特点。

CHARACTERISTIC

Huayuan High Strength Particle Coating has the characteristics of high durability, high hardness, high heat insulation, sound insulation, non condensation, long-term mildew resistance, etc.

用途

高档建筑、墙板、办公楼、医院护理、食品加工、屋顶、轨道车体等对涂层有高要求的区域。



APPLICATION

High grade building, wallboard, office building, hospital nursing, food processing, roof, rail car body and other areas with high requirements for coating.

Huayuan Chameleon Aluminium Composite Panel

华源幻彩铝复合板

特别推荐 3

幻彩原理

用特殊涂装工艺将两种或两种以上不同的颜色烤在同一平面，利用光线和物质之间的折射、反射，让幻彩铝复合板在不同的角度，呈现不一样的颜色。颜色自然，让建筑流光溢彩，赏心悦目！

The colour transition is natural, which makes the building shine with shimmer and attractive.

CHARACTERISTIC

The panel is baked two or more different colours in a special coating process on the same surface, taking the advantages of refraction and reflection between lights. Then the Chameleon Aluminium Composite Panel will present dynamic colour shifting under different angles.

双色幻彩



双色幻彩



多色幻彩





Huayuan Anodized Aluminium Composite Panel

华源阳极氧化铝复合板 特别推荐 4

特点

以铝板为阳极置于电解质溶液中，利用电解作用，使其表面形成氧化铝薄膜的过程，称为铝板的阳极氧化处理。特点：金属感强、表面硬度高、抗刮性好、不腐蚀，不氧化，不生锈。

CHARACTERISTIC

The aluminium alloy is used as the anode and placed in the electrolyte solution. This forms an aluminium oxide film on its surface called the anodizing process of aluminium alloy. Features: strong metallic feeling, high surface hardness, good scratch resistance, no corrosion, no oxidation, no rust.

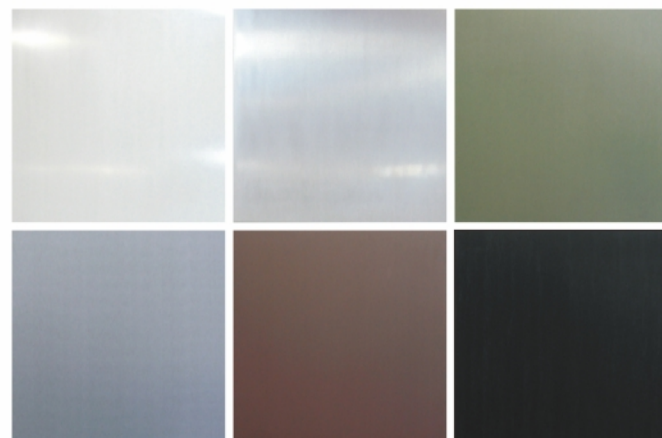

Huayuan Film Metal Composite Panel

华源金属覆膜板 特别推荐 5

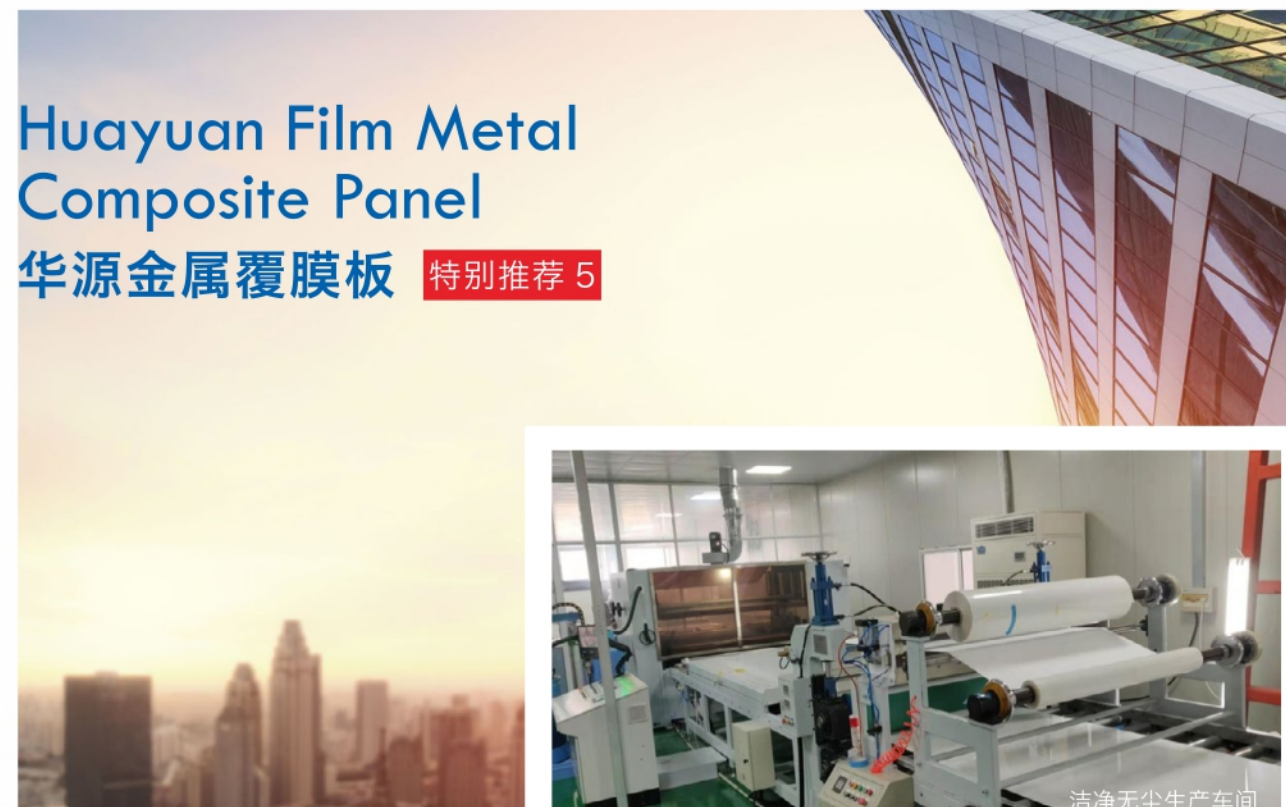

系统化、模块化安装

可开槽、折弯加工，配合连接件可实现室内墙板的系统化、模板化，省时省力。

耐候、防潮

产品耐候性强，耐酸碱，不褪色，具有防潮性能。

自然环保

产品通过国家环保认证，安装过程中无需使用任何胶水，绿色环保。测试结果达到 E1 级，可直接用于室内装饰。

色彩丰富、纹理自然

有木纹、石纹、皮纹、纯色等。

防火性

防火符合国家室内防火标准，可达 A2 级。

抗刮性

表面含有硬质成分，能够保护表面免受损伤，抗刮性能优于烤漆面材料。

抗菌性

抗菌系列，板面具有抗菌功能，保持了面板的清洁性。

Systematic and modular installation

It can be slotted and bent, and can be used to connect indoor wall panels with connecting pieces. Unified and templated, saving time and labor.

Weather and moisture resistance

The product has strong weather resistance, acid and alkali resistance, it does not fade and has moisture resistance.

Environment Friendly

The product has passed the national environmental protection certification. No glue is required during the installation, which allows direct application for indoor.

Rich Colors And Vivid Texture

There are wood grain, stone grain, leather grain, solid color and so on.

Fire resistance

Fire resistance complies with national indoor fire resistance standards and can reach A2 grade.

Scratch Resistance

The surface contains hard ingredients, which can protect the surface from damage and scratch. It's better than coating.

Antibacterial

The surface has an antibacterial function, keeping the cleanliness of the panel.

Huayuan Copper Composite Panel, New Material For Facade

华源铜复合板 幕墙新材料

铜的色彩自然丰富，随时间的变化而变化
Copper is naturally rich in colour and changes with time



铜复合板结构上采用铜/芯/铝复合而成，表面平整度高，易于加工。比单铜板节省大量铜材。公司直接用真铜复合，全部保留了铜金属原有的金属质感和装饰效果，是其他仿品和涂装工艺所不能比拟的，色彩和效果具有不可复制的唯一性，时尚华丽和古朴高贵并存。

CHARACTERISTIC

The Copper Composite Panel is laminated with a copper/core/aluminium sandwich structure, which has an excellent surface flatness and is easy to process. It saves a lot of copper than the solid copper panel. The panel is composed of real copper with the original metallic texture and decorative effect. It is unmatched by other imitations and painting processes. The colour and effect have a uniqueness that cannot be copied. It has a gorgeous, aged look.



Huayuan Zinc Composite Panel New Materials For Facades

华源钛锌复合板 幕墙新材料

特点

钛锌复合板结构上采用钛锌/芯/铝，经热复合而成，是一种国际新型的高档建筑装饰材料。产品集钛锌板的特点（金属质感强、表层具有自我修复功能、使用寿命长、塑性好等特点），结合复合板强度高、平整度好、重量轻、价格低的优点于一体。古朴、稳重、高雅。

CHARACTERISTIC

The Zinc Composite Panel adopts a zinc / core / aluminium sandwich structure. It is made of continual lamination under high temperature and pressure. It's a new high-grade building decorative material. It combines the features of zinc (strong metallic texture, self-healing of the surface, long lifetime and flexibility) and composite panel (rigidity, superior flatness, light weight and low price). Classic and elegant.





Huayuan Stainless Steel Composite Panel New Materials For Facades 华源不锈钢复合板 幕墙新材料

特点

不锈钢复合板结构上采用不锈钢 / 芯 / 不锈钢夹层结构，经热复合而成的高档建筑装饰材料。产品完美保留了不锈钢的品质，光亮、质硬、耐磨和耐腐蚀性强。力学性能优异，经久耐用，适用于各种复杂环境。

CHARACTERISTIC

Stainless Steel Composite Panel is laminated by a structure of stainless steel / core / stainless steel. It is made of continuous lamination under high temperature and pressure. It's a new high-grade building decorative material. It perfectly retains the shiny surface, high rigidity, wear resistance and corrosion resistance of stainless steel. It is excellent in mechanical properties, durable and suitable for all kinds of complex surroundings.



Huayuan Galvanized Steel Composite Panel 华源镀锌钢复合板

特点

结构上采用钢 / 芯 / 钢夹层结构，经热复合而成的新型装饰材料。可涂装各种色彩涂层和覆膜。表面花纹色彩丰富、环保、耐久性好（耐磨、耐腐蚀），并具有良好的加工性能。作为彩涂钢板的升级产品，可广泛应用于电梯、门业、家电等装饰行业。

CHARACTERISTIC

It is laminated by a structure of steel / core / steel. It is made of continuous lamination under high temperature and pressure. The surface pattern is rich in color, environment-friendly with good durability (wear resistance and corrosion resistance), and has good processing performance. It can be applied in elevator and escalator, door and home appliances as an upgrade product of color coated steel plate.

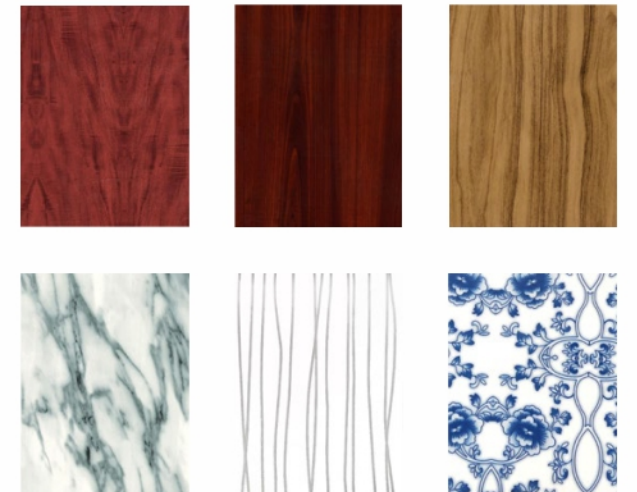



Huayuan Aluminium C-core Panel 华源三维复合板

特点

三维复合板采用三维物理结构，使用特有的粘结技术，通过智能多功能生产成套设备复合而成。其三维芯层结构兼顾柔韧和刚性强度，质轻坚固，板面平整，强度高、易加工，环保且防火等级可达到 A2 级，加工便捷。外观效果多样，拉丝、石纹、木纹、花式覆膜都可以完美展现。

CHARACTERISTIC

Aluminium C-core panel adopts 3D physical structure and uses unique bonding technology.

It is compounded by multifunctional production equipment. The C-core structure combines flexibility and rigidity with light weight and strength. Easy to process, environmental-friendly and reaches to fire-resistance A2. It has various surfaces and patterns as brushed, stone, wood grains and special patterns.

三维铝复合板截面图



普通铝塑板截面图

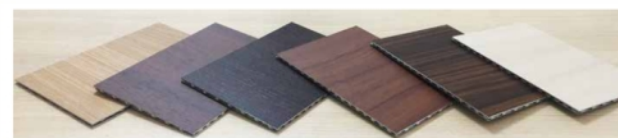

Huayuan Aluminium Honeycomb Panel 华源铝蜂窝复合板

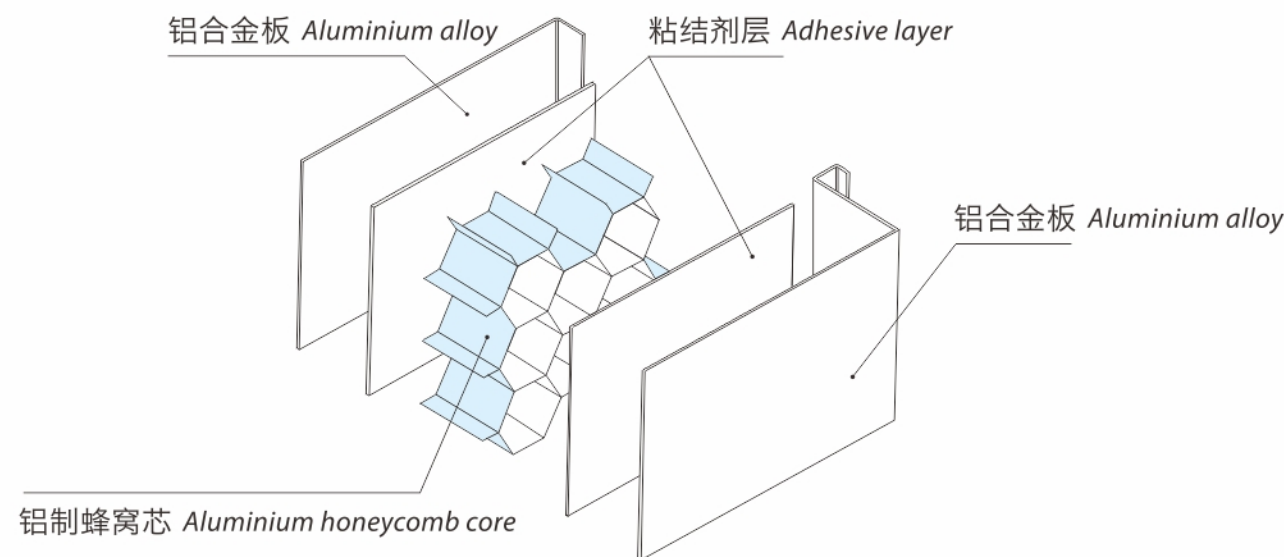
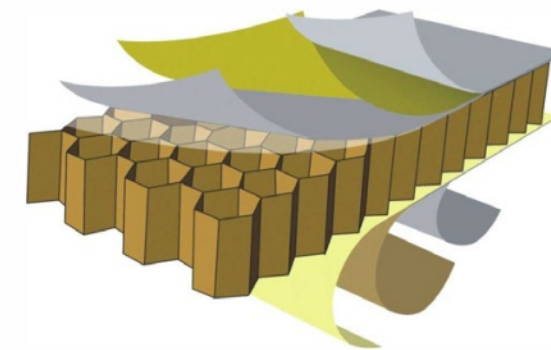

特点

具有抗高压、减震、隔音、保温、阻燃和比强度高优良性能。铝蜂窝复合板一般采用氟碳滚涂铝板做面板。采用了连续的辊涂工艺，铝板的涂漆是一性完成的，保证其产品无色差，涂层流平度好，质量可靠。同时能长时间保持建筑物外墙颜色鲜艳。经过长期日晒雨淋或工业废气污染后，很明显辊涂板要比喷涂板洁净光亮，并具有良好的附着力和耐候性，是世界建筑人士公认的第一流材料。

CHARACTERISTIC

It has the following features: wind load resistance, shock absorption, sound insulation, thermal insulation, fire resistance, high strength, etc. Aluminium Honeycomb Panels generally use PVDF coated aluminium sheet by a continuous roller coating process, which is coated by one time to ensure the colour consistency, even coating thickness, and reliable quality. This can also retain the vivid and bright colour of the building exterior. After being exposed to the sun and rain or industrial waste, it is obvious that the panel adopting roller coating is brighter than the ones treated by spraying coating. Roller coating makes the panel has good adhesion strength and weather resistance. The roller coating is recognized as the first-class treatment in this product globally.



Huayuan Metal Stone Composite Panel

华源金属石材复合板

特点

华源金属石材复合板是以5mm~7mm的石材薄板与铝蜂窝板通过胶粘剂复合而成的一种新型建筑装饰材料，既保留了石材的天然效果，又节省了珍贵石材且极大地减轻了成品的重量。产品比普通天然石材具有更好的抗冲击性，每平方米仅为8~11千克，是普通天然石材重量的1/7，抗压强度却是它的3~5倍，完全克服了天然石材重量大、易碎等缺陷。

华源金属石材复合板是一种性能更为优异和应用领域更为广泛的新一代建筑材料。

CHARACTERISTIC

Huayuan metal stone composite panel is a new type of building material, which is composed of 5mm ~ 7mm stone plate and aluminium honeycomb base material by adhesive, which completely retains the actual effect of stone, saves precious stone and greatly reduces the weight of finished products. It has better impact resistance than ordinary natural stone. It is only 8-11kg per square meter, 1/7 of the weight of ordinary natural stone, and its compressive strength is 3-5 times of it. It completely overcomes the defects of natural stone, such as large weight and fragile.

Huayuan metal stone composite panel is a new generation of building materials with more excellent performance and more extensive application fields.

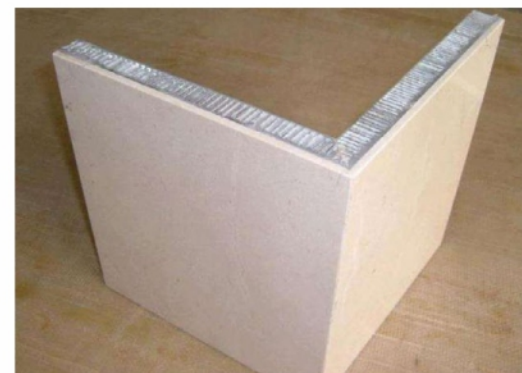

分类

- 蜂窝结构板与石材复合
- 防火复合板与石材复合
- 三维复合板与石材复合

CLASSIFICATION

- Composition of honeycomb structure panel and stone
- Composition of fireproof composite panel and stone
- Composition of three dimensional composite panel and stone

优势

具有重量轻、强度高、辐射小、节省石材、板面尺寸大，又兼具防潮、隔音、隔热、防寒等优点。

ADVANTAGE

The utility model has the advantages of light weight, high strength, small radiation, stone saving, large board size, moisture-proof, sound insulation, heat insulation, cold resistance, etc.

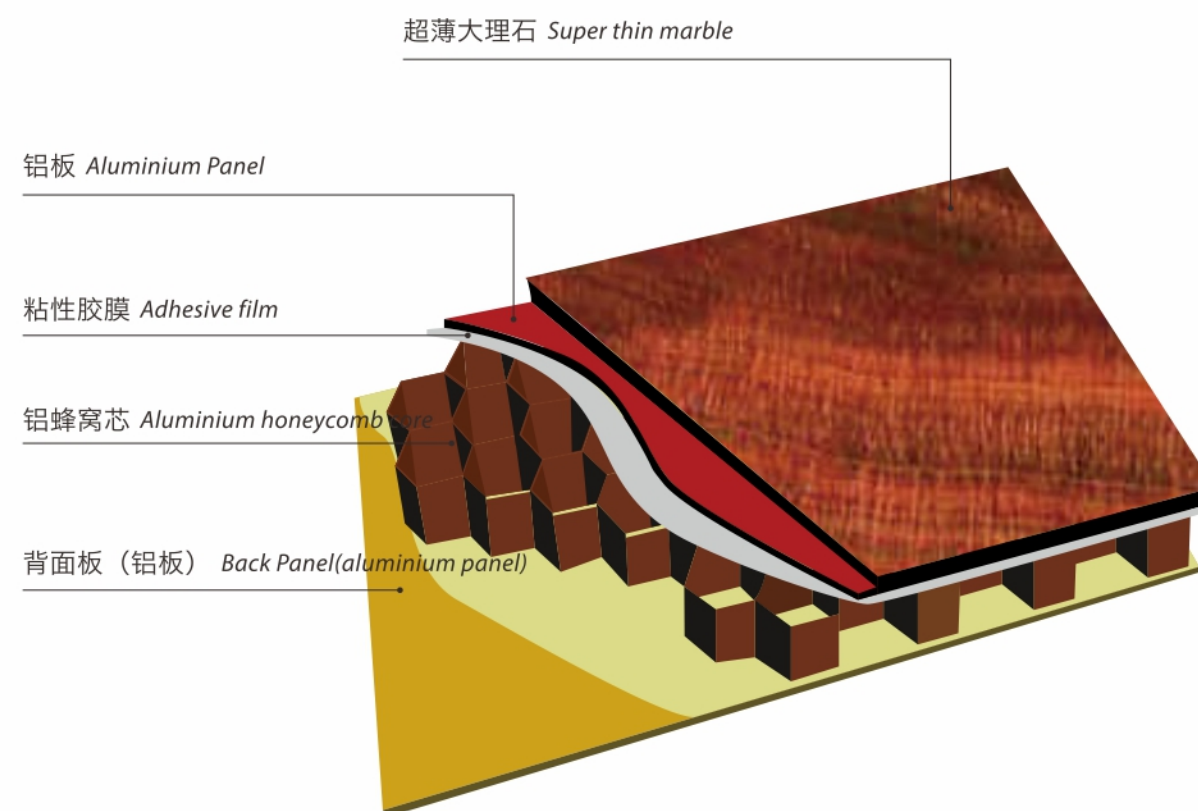

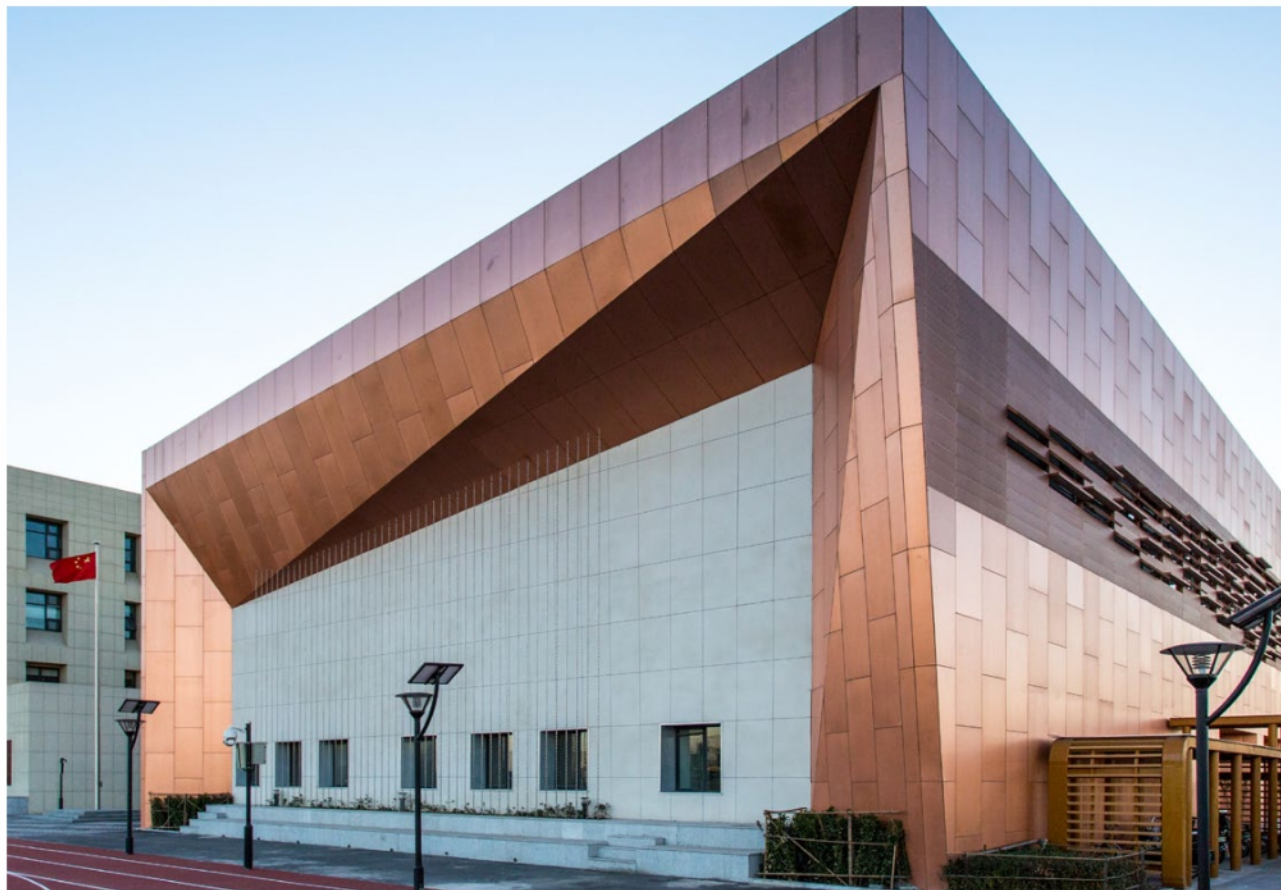

Huayuan Installation System For Metal Composite Panel 华源复合板安装系统

密闭式幕墙系统
Secret fix system



开放式幕墙系统
Open joint non-sealant system

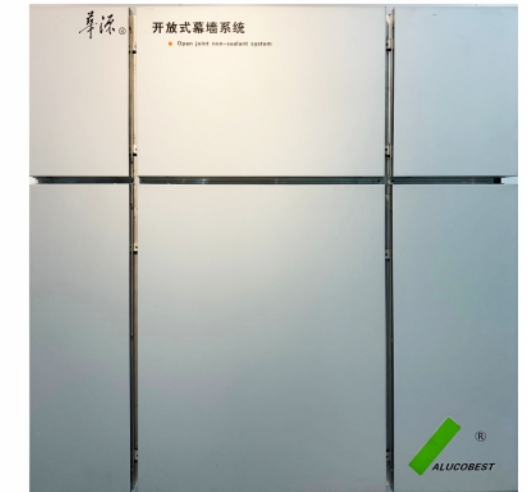

Huayuan Bimetal Composite Panel 华源双金属复合板

产品分类

- 铜 | 铝双金属复合板
- 不锈钢 | 铝 (或镀锌钢) 双金属复合板
- 钛锌 | 铝双金属复合板
- 铝 | 镀锌钢双金属复合板

PRODUCT CATEGORY

- Copper-Aluminium Bimetal Composite Panel
- Stainless Steel-Aluminium (or Galvanized Steel) Bimetal Composite Panel
- Zinc-Aluminium Bimetal Composite Panel
- Aluminium-Galvanized Steel Bimetal Composite Panel

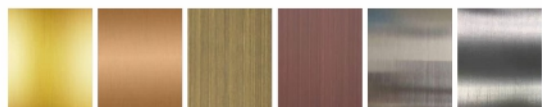

特点

既保持了金属原有的特性，经复合又提高了产品的强度、平整度，兼具了良好的减震、降噪、隔热等优点。

CHARACTERISTIC

It not only combines with the original characteristics of the metal but also improves the product's strength, flatness, shock absorption, noise reduction, and heat insulation, etc.

采用两种不同金属直接复合的工艺。

总厚度可达 **3mm**

We adopt the direct composition process of two different metals.

Total thickness can be up to

3mm

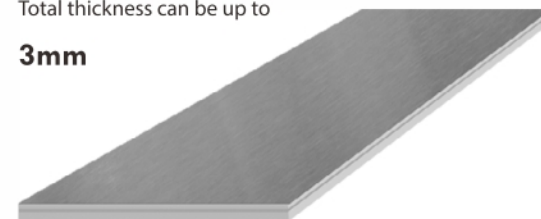

密缝安装系统 (内装)
Seamless fixing system
for interior

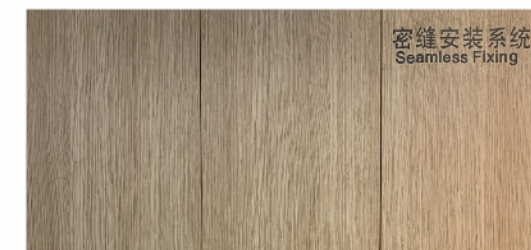

离缝安装系统 (内装)
Open-joint fixing system
for interior

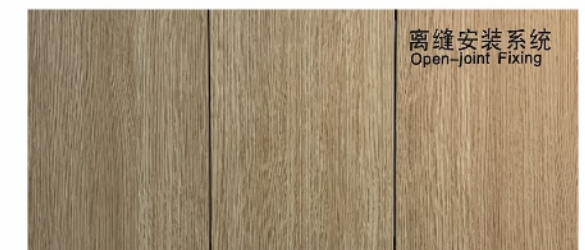

明框安装系统 (内装)
Open-frame fixing system
for interior



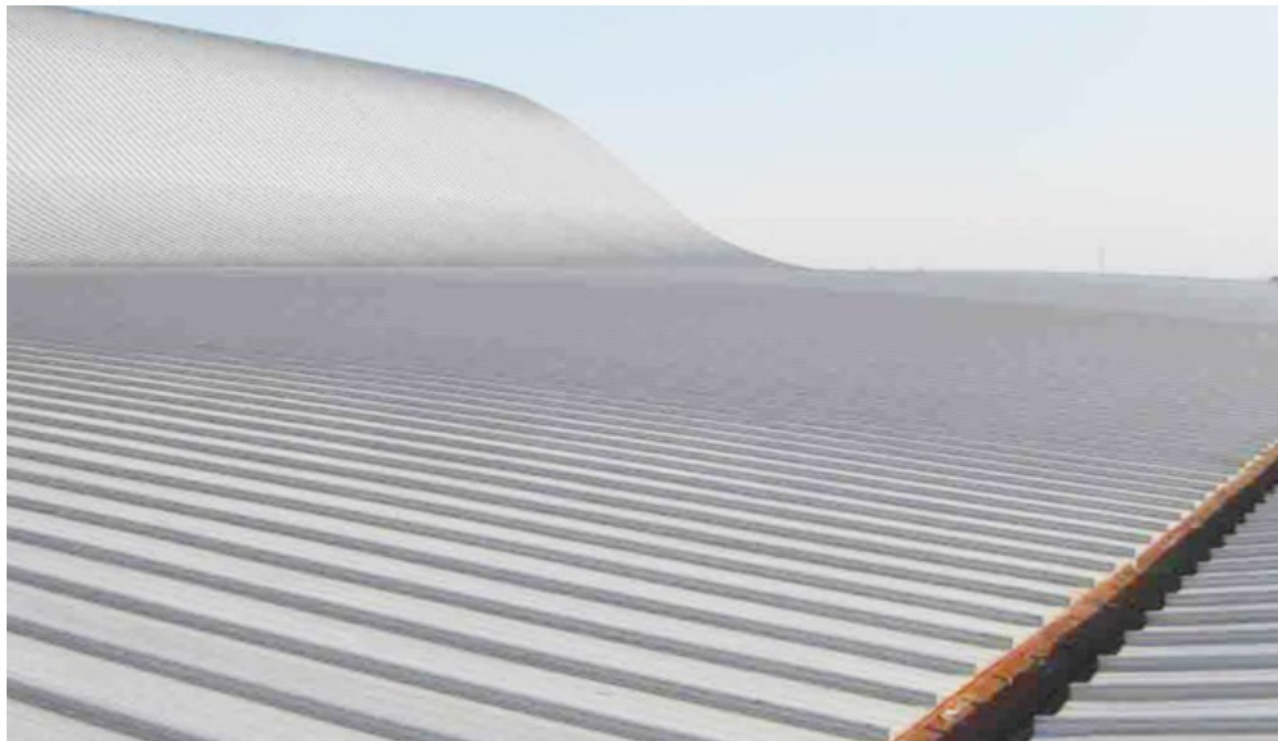

Huayuan Al-mg-mn Solid Panel 华源铝镁锰板

是一种高性价比的屋面和外墙材料，在建筑业中得以广泛应用。产品以结构强度适中、耐候好、易于折弯焊接加工等优点，被普遍作为建筑设计中使用寿命 50 年以上的屋面、外墙材料。

氟碳辊涂铝镁锰板，采用预辊涂工艺，色差控制好、漆膜均匀、质量稳定，涂层种类选用含氟碳树脂 70% 以上的氟碳涂料，可根据客户定制颜色。

It is a cost-effective roofing and exterior wall material and widely used in the building construction industry. It is a kind of product with moderate structural strength, good weather resistance and easy processing (folding, bending, welding, etc), which allows the common application in roofing and exterior wall for more than 50 years.

The PVDF roller coated aluminium magnesium manganese solid panel applies a pre-roller coating process under good colour variation control. The coating thickness is even, reliable, the coating applies paint with more than 70% fluorocarbon resins. Customized colours are available.

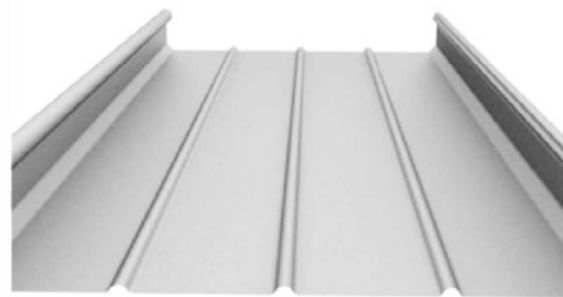

铝镁锰板的特点：

- 重量轻
- 强度高
- 耐腐蚀
- 可塑性好，易加工
- 安装方便
- 环保，100% 可循环回收利用

用途

广泛应用于机场航站楼、车站及大型交通枢纽、会议及展览中心、体育场馆、展示厅、大型公共娱乐设施、公共服务建筑、大型购物中心、商业设施、民用住宅等建筑屋面与墙面系统。

铝镁锰板屋面使用“华源高强度粒子涂层”，具有“高绝热”功效，能明显降低屋顶和室内温度。

CHARACTERISTIC

- Light weight
- High strength
- Corrosion resistance
- Good plasticity, easy to process
- Easy installation
- Environmental protection, 100% recyclable

APPLICATION

It is widely used in the roof and wall systems of airport terminals, stations and large-scale transportation hubs, conference and exhibition centers, stadiums, exhibition halls, large-scale public entertainment facilities, public service buildings, large-scale shopping centers, commercial facilities, civil residential buildings, etc.

Aluminium magnesium manganese solid panel roof uses "Huayuan High Strength Particle Coating", which has a high thermal insulation effect and can significantly reduce the temperature of the roof and the room.

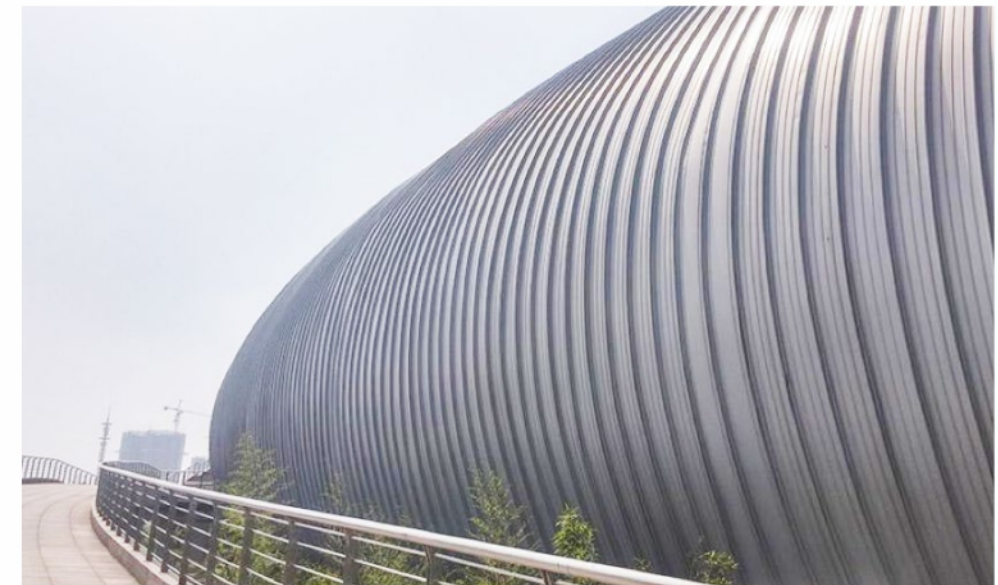

安装系统

通过使用专业的立边和咬合设备，在沿着板条长度方向上将两块板的立边进行咬合，从而将屋面或墙面连接成为一个整体。系统不需要打胶，100% 结构性防水。这个系统可以节省很多安装时间，尤其对于面积较大的屋面或墙面，提供了一个有效降低成本的方法。

INSTALLATION SYSTEM

By using professional edging and connecting equipment, we connect the vertical edges of the two panels along the longitude direction to building the roof or wall as a whole system. This system does not need to be glued, 100% knot structural waterproof, which offers a cost-effective method of saving a lot of installation time, especially for large roofs or walls.

Metal Composite Panel Production Process

金属复合板生产工艺流程

華源

1 化成线 / Chromating Line

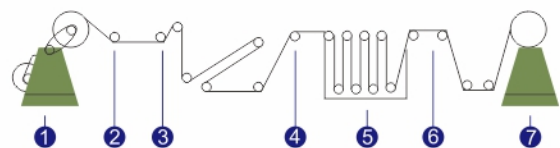

- | | |
|---------|--------------------|
| 1. 放卷 | 1. Unroll |
| 2. 毛刷脱脂 | 2. Degrease |
| 3. 浸浴脱脂 | 3. Degrease |
| 4. 中和处理 | 4. Neutrualization |
| 5. 皮膜化成 | 5. Chromating |
| 6. 干燥 | 6. Drying |
| 7. 收卷 | 7. Rolling |



2 精密涂装线 / Precision Coating Line

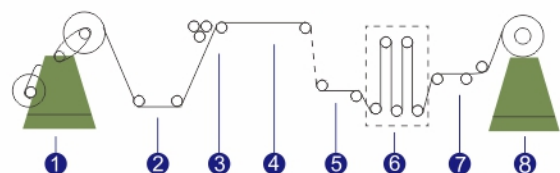

- | | |
|---------|---------------------|
| 1. 放卷 | 1. Unroll |
| 2. 干燥 | 2. Drying |
| 3. 三辊涂装 | 3. 3 Roller Coating |
| 4. 高温烤漆 | 4. Toasting |
| 5. 输送 | 5. Transfer |
| 6. 储料 | 6. Storage |
| 7. 质量检测 | 7. QC |
| 8. 收卷 | 8. Rolling |



3 连续热贴复合线 / Continuous Laminating Line

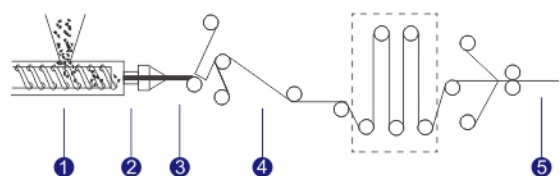

- | | |
|-----------|-----------------|
| 1. PE挤压 | 1. PE Extrusion |
| 2. 整平成形 | 2. Smoothing |
| 3. 预贴高分子膜 | 3. Film |
| 4. 输送 | 4. Transfer |
| 5. 复合定形 | 5. Laminate |



Metal Composite Panel Production Process

金属复合板生产工艺流程

華源

1 化成线 / Chromating Line

介绍

化成线起着清洗铝卷表面附着的一层轧压过程中轧压润滑油、防氧化油脂及各种污垢的作用，并去掉硅、镁、铜等不纯物在铝材表面的沉析。公司选用德国汉高公司的优质化工原料及技术对铝卷表面进行化成处理，在铝卷表面形成结构致密的蜂巢状氧化皮膜，使油漆与铝卷，铝卷与芯料通过这一中介物紧紧地结合在一起，具有良好的附着力。

INTRODUCE

The chromating line is to clean the lubricating grease and anti-oxidative grease adhesive to the surface while being rolled, and other impurities such as silicon, magnesium, iron, and copper that deposit on the surface of aluminium alloy. The company uses qualified industrial chemicals and advanced technology from German Henkel co.,ltd. to have a chromating dealing with the surface of aluminium alloy. Through this technology, the aluminium surface is covered with a honeycomb oxidative film of high density, which bonds the coating and aluminium firmly. This film has a very strong adhesive force.

2 精密涂装线 / Precision Coating Line

介绍

精密涂装线是化成后的铝卷按客户所需涂装各种油漆。公司涂装采用国际先进的精密三辊逆向辊涂机，在封闭无尘的状态下进行精密涂装，使涂膜厚度和涂层外观质量得到良好控制；烤炉分四区控温烘烤，使涂层的耐溶剂性、硬度、柔韧性均达到最佳状态。具有良好的光泽性、附着力和抗腐蚀性。

INTRODUCE

The precision coating line is to coat the chromated aluminium alloy with various paints according to customers. The company has an advanced three-roller reversal precision coating machine that can operate under sealed, dustless conditions so that the coating thickness and its outer appearance is controlled properly. The oven is divided into four temperature-controlled areas to make the coating reach the best condition for solvent resistance, hardness, flexibility, good glossiness, strong adhesive force, and corrosion resistance.

3 连续热贴复合线 / Continuous Laminating Line

介绍

连续热贴复合线是铝复合板成形的关键设备，其作用是使铝材、PE芯材与高分子膜在连续高温高压的作用下牢固地粘合，形成平整板面。公司选用进口高分子膜，依靠先进的设备，完美的工艺，严格的控制，使铝复合板具有超强的剥离度，已经超出进口板的指标。

INTRODUCE

This is the key equipment for producing Aluminium Composite Panel. It can make aluminium, PE core and adhesive polymer film firmly bonded to one another under high heat and high pressure so that the panel is extremely smooth and flat. With imported qualified adhesive polymer film, advanced equipment, perfect technology and strict quality control, the peel strength of our Aluminium Composite Panel is two times higher than the national standard and superior to the quality index of the international famous brand.

Metal Composite Panel Processing Method

金属复合板加工方法



介绍

华源牌铝复合板只要用加工木材或金属的工具就可进行剪、锯、铣、冲、压、折、弯等加工成型，可按建筑装修设计的要求加工成各种造型，尤其对弧形、反弧形、小半径圆角、内外转角等造型更是随心所欲，是其他装修材料所不能相比的。

普通的铝制品加工机械和木制品加工机械不需特殊装置就可用于华源板的加工。

INTRODUCE

Huayuan brand Aluminium Composite Panel only require wood or metal tools to do cutting, sawing, milling, punching, pressing, folding, bending, etc.

It can be processed into various shapes according to architectural decoration design, especially for arcs shape, reverse arc, small radius fillet, inner and outer corners, etc. No other decorative material can compare with it.

锯断加工 / Saw Cutting

用木制品加工用机械锯和板就能简单地进行加工。本公司推荐使用硬质合金刀片。

Simple processing is available for mechanical saws and boards for wood processing.

We recommend to use carbide inserts.



剪断加工沟槽加工 / Shearing and Slotting

距离聚乙烯基面保持 0.2-0.4mm 的 V 型沟槽加工是很重要的。

本公司推荐的最佳沟槽角度为 110°

• 铣床和修剪器

如右图所示使用平头 V 形刀具。

转速：20,000-30,000rpm

进刀转速：3-5m/min

材质：硬质合金

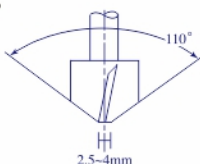

• 当大量加工 V 型沟槽时

使用圆形锯和带锯为适当。下例所示的为一个槽刀的例子；

• 材质：硬质合金片

• 外径：305mm

• 齿数：24

• 转速：3,000-5,000rpm

• 进刀速度：5m/min

开槽中心线离铝复合板边缘大于 20mm



Shearing and Slotting

It is very important to leave 0.2-0.4mm for V groove gap away from the polyethylene substrate

The best groove angle recommended by our company is 110°

• Milling Machine And Trimmer

Use a flat V-shaped tool as shown on the picture.

Number of revolutions: 20,000-30,000rpm

Feeding speed: 3-5m / min

Material: Carbide

• When processing large quantity of V type slots

When a large number of V-grooves are processed. The appropriate tool is circular and band saws. The following picture shows an example.

• Material: Carbide

• External Diameter: 305mm

• Number Of Teeth: 24

• Speed: 3,000-5,000rpm

• Feed Speed: 5m/min

The slotted center-line should be over 20mm from the edge of the aluminium composite panel

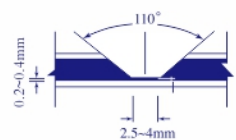

Metal Composite Panel Processing Method

金属复合板加工方法



用平台弯曲加工 /

Bending with the platform

在平台进行操作、弯曲部分可以做得很整齐。

If the bending is operated on the platform, bending part can be made very tidy.



用折板机弯曲加工 /

Bending With Panel Bender

当使用折板机整形板时，应使用适当半径上模。

When the panel bender is used to process panel, dies shall be placed on with an appropriate radius.

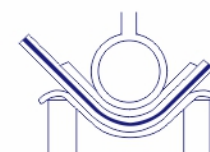

用三辊弯板机弯曲加工 /

Bending With 3-Roller Panel Bender

三辊弯板机较之折板机适用于大内径的弯曲。

A 3-roller panel bender is more preferable for bending large internal diameter of the panel.

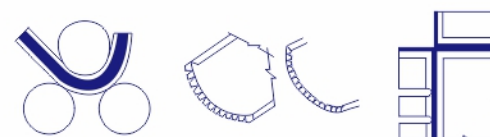

铆接加工 / Riveting

抽芯铆钉可以方便地从一方向进行连接。

Blind rivets can be easily connected on the panel from one direction.



栓接 / Bolting

从变形极限考虑，图中 $e \geq 2D$ 。

Considering from deformation limit, formula $e \geq 2D$.

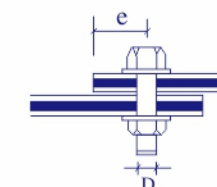

Metal Composite Panel Processing Method

金属复合板加工方法

华源

板的类型和连接设计实例 (A) / Example Of Panel Type And Joint Design(A)

角铝和密封连接 (1) Angle Aluminium and seal joint (1)

- ① 华源板 HUAYUAN Panel
- ② 铝铆钉 Aluminium rivet
- ③ 角铝 (大) Angle Aluminium
- ④ 角铝 (小) Angle Aluminium
- ⑤ 垫衬材料 Back spacer
- ⑥ 密封材料 Sealing material
- ⑦ 垫片 Spacer
- ⑧ 角钢 Angle bar
- ⑨ 圆头螺钉 Bullen screw

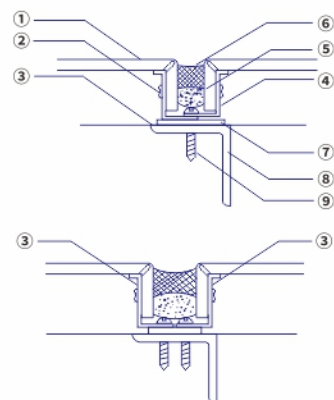

圆柱包覆实例 / Example Of Column Covering

- ① 华源板 HUAYUAN Panel
- ② 角支撑 Angle support
- ③ 钢板条 Steel plate strip
- ④ 密封材料 Sealing material
- ⑤ 塑料衬垫 Plastic lining bar
- ⑥ 附属装置 Accessories
- ⑦ 圆头螺钉 Bullen screw
- ⑧ 承重柱 Bearing strut
- ⑨ 角钢 Angel bar

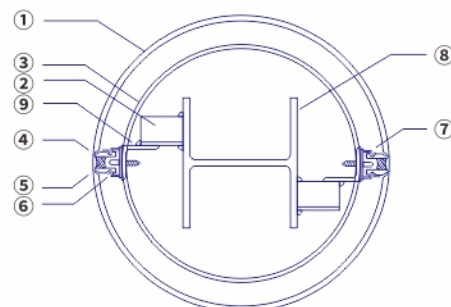

以上附属装置适用于低层建筑
Above mentioned accessories are used for low buildings.

建筑顶部安装实例 / Installation Example Of Building Top

- ① 华源板 HUAYUAN Panel
- ② 建筑顶部 Building top
- ③ 角支撑 Angle support
- ④ 角支撑 Angle support
- ⑤ 角钢 Angle bar
- ⑥ 密封材料 Sealing material
- ⑦ 衬垫材料 Lining material
- ⑧ 圆头螺钉 Bullen Screw
- ⑨ 预埋锚固或膨胀螺栓 Built-in anchoring or expanding bolt

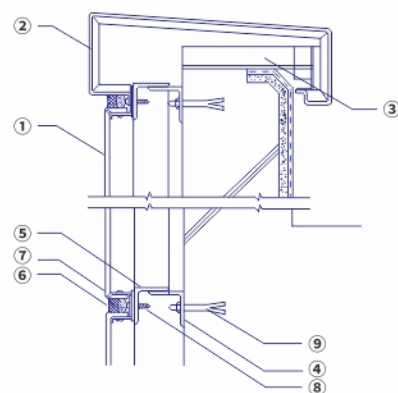

Metal Composite Panel Processing Method

金属复合板加工方法

华源

外部拐角处安装实例 / Installation Example Of External Corner

- ① 华源板 HUAYUAN Panel
- ② 密封材料 Sealing material
- ③ 衬垫材料 Lining material
- ④ 角钢 Angle bar
- ⑤ 钢板条 Steel plate strip

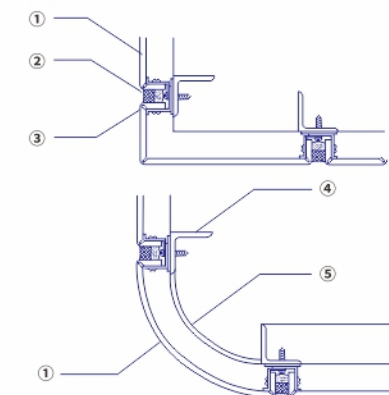

内部拐角处安装实例 / Installation Example Of Internal Corner

- ① 华源板 HUAYUAN Panel
- ② 密封材料 Sealing material
- ③ 衬垫材料 Lining material
- ④ 角钢 Angle bar
- ⑤ 圆头螺钉 Bullen screw

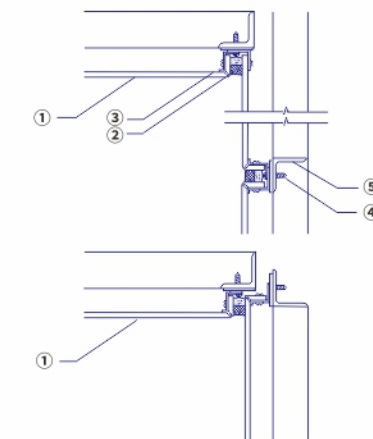

方柱包覆实例 / Example Of Strut Covering

- ① 华源板 HUAYUAN Panel
- ② 角支撑 Angle support
- ③ 角钢 Angle bar
- ④ 密封材料 Sealing material
- ⑤ 塑料衬垫 Plastic lining bar
- ⑥ 附属装置 Accessories
- ⑦ 圆头螺钉 Bullen screw
- ⑧ 承重柱 Bearing strut

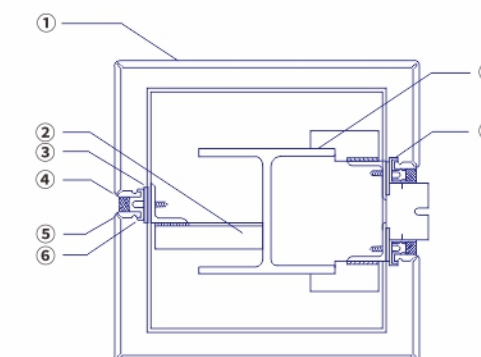

以上附属装置适用于低层建筑
Above mentioned accessories are used for low buildings

Huayuan Product Development and Testing Center 华源产品研发与测试中心

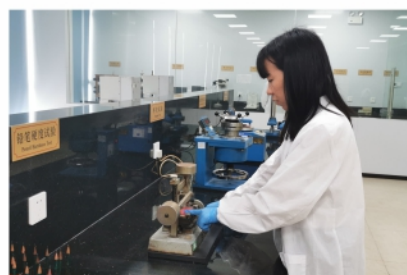

Huayuan Product Processing Equipment 华源产品加工设备



数控精密雕刻机
CNC Precision Engraving Machine

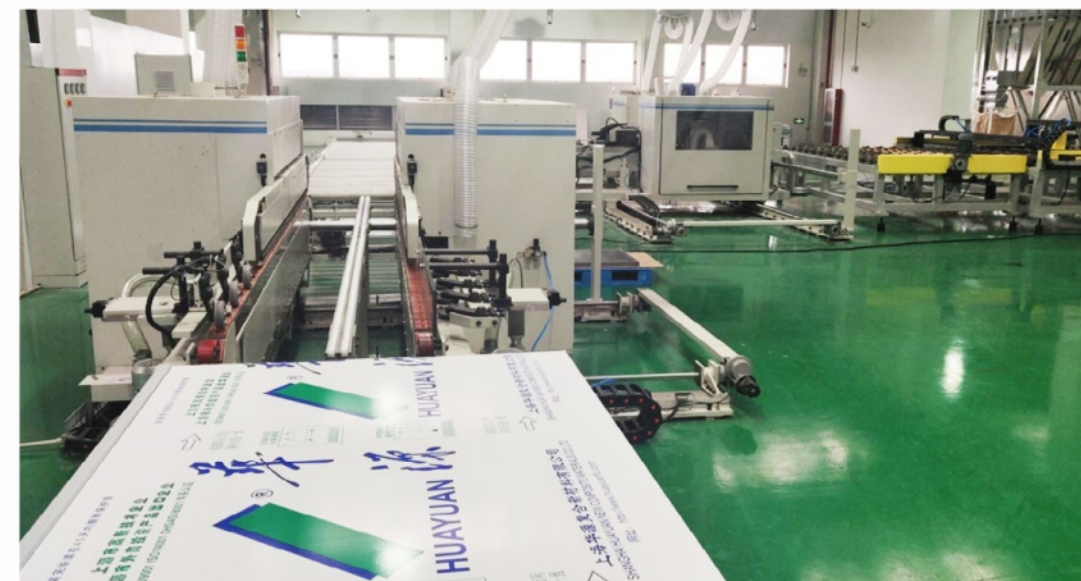

大型数控专业开槽机
CNC Slotting Machine

Our Service (one-stop service) 我们的服务 (一站式服务)

设计服务
Design service



测试、验证服务
Test and verification services



一站式服务
One stop service

物流、仓储服务
Logistics and warehousing services



生产制造服务
Manufacturing services



提供服务

▪ 产品设计 ▪ 安装设计 ▪ 产前打样 ▪ 产品生产 ▪ 产品加工 ▪ 成品供货 ▪ 完整配套

PROVIDE SERVICES

▪ Product Design ▪ Installation Design ▪ Pre Production Proofing ▪ Product Production ▪ Product Processing
▪ Finished Product Supply ▪ Complete Set

Project Reference

工程实例选登

图例 1、2、3 世界中学生运动会主场馆、游泳馆 约 130000m²



Project Reference

工程实例选登

图例 1 上海仁恒公园世纪 约 110000m²
图例 2 上海浦东万科翡翠滨江外墙 约 10000m²

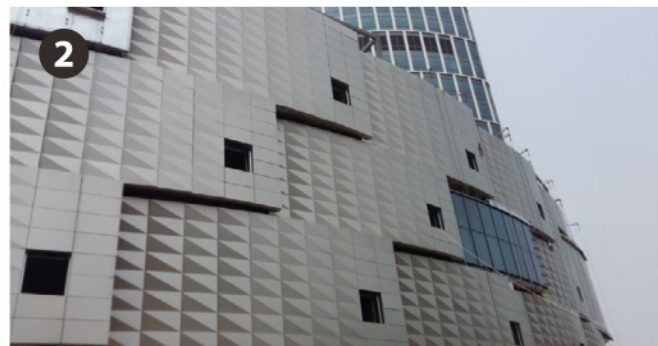

中国优质铝复合板示范工程

图例 3 上海 F1 国际方程式赛车场 约 100000m² 图例 5 吉林省政府大厦 约 20000m²
图例 4 上海世博会主题馆 约 12000m²



图例 6、7 又见马六甲工程 约 30000 多 m²



Project Reference

工程实例选登

图例 1 三一重工临港产业基地 约 30000m²

图例 2 石药集团兴石制药有限公司 约 160000m²

图例 3 横琴口岸 约 60000m²

图例 4 上海世博会主题馆 约 12000m²

图例 5 吉他酒店

图例 6 上海中山医院

图例 7 安徽六安儿童医院

图例 8 上海瑞金医院



Project Reference

工程实例选登

图例 1、2 硕放机场
图例 3、4 青岛流亭机场
图例 5 上海世博村公寓



图例 6、7 天津博物馆 约 5000m²

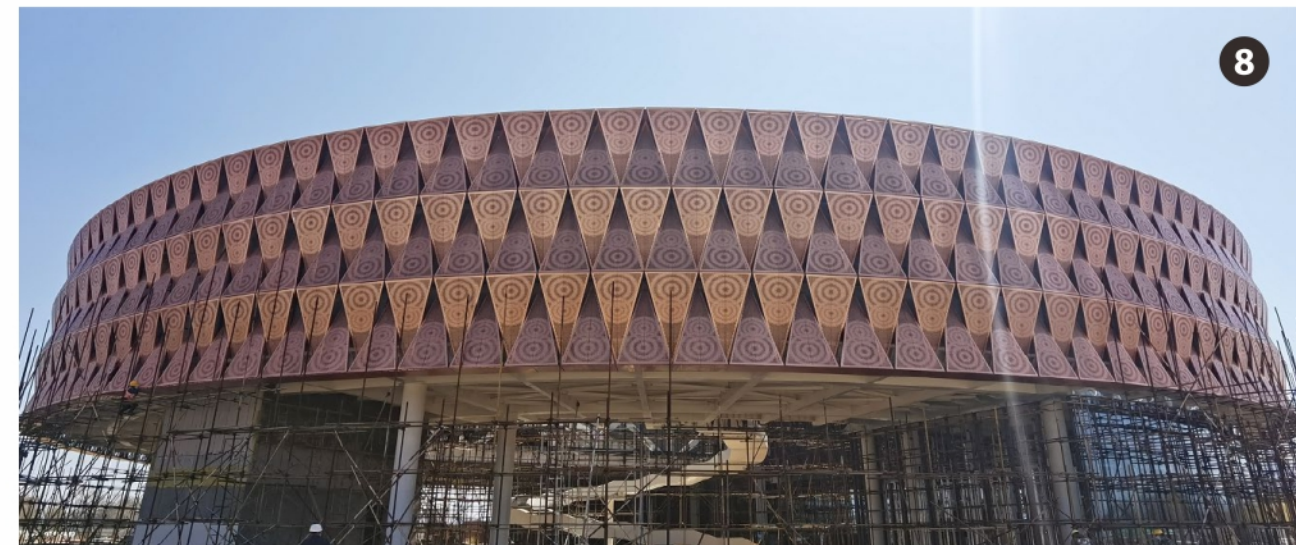

图例 8 河北官厅水库湿地博物馆
图例 9 华润温州滨江售楼处